

"Why compete against your supplier when you can be our partner"

Pulley (dw)	Grooves	Bush	d2 Max	Type	L	b	d3	d1	d	App. Kg
63	1	1008/1108	25/28			20			69	0.6
	2	1008/1108	25/28			35			69	0.8
67	1	1108	28			20			73	0.4
	2	1108	28			35			73	0.6
71	1	1108	28			20			79	0.4
	2	1108	28			35			79	0.6
	3	1108	28			50			79	0.8
75	1	1108	28			20			80.6	0.5
	2	1108	28			35			80.6	0.7
80	1	1210	32			20			85.6	.5
	2	1108/1210	28/32			35			85.6	.75
	3	1210	32			50			85.6	.95
85	1	1210	32			20			90.6	.6
	2	1210	32			35			90.6	.8
	3	1210	32			50			90.6	1.00
90	1	1210	32			20			95.6	.7
	2	1610	42			35			95.6	.8
	3	1610	42			50			95.6	1.05
	4	1615	42			65			95.6	1.35
95	1	1210	32			20			100.6	.8
	2	1610	42			35			100.6	1
	3	1610	42			50			100.6	1.2
	4	1615	42			65			100.6	1.5
100	1	1610	42			20			105.6	.85
	2	1610	42			35			105.6	1
	3	1610	42			50			105.6	1.40
	4	1610/1615	42			65			105.6	1.8
	5	1615	42			80			105.6	2.2
	6	1610/1615	42			95			105.6	2.35
106	1	1610	42			20			111.6	1
	2	1610	42			35			111.6	1.3
	3	1610	42			50			111.6	1.5
	4	2012	50			65			111.6	1.7
	5	2012	50			80			111.6	2.10
	6	2012	50			95			111.6	2.4
112	1	1610	42			20			117.6	1.05
	2	1610	42			35			117.6	1.35
	3	2012	50			50			117.6	1.8
	4	2012	50			65			117.6	2
	5	2012	50			80			117.6	2.5
	6	2012	50			95			117.6	2.7
118	1	1610	42			2			123.6	1.2
	2	1610	42			4			123.6	1.6
	3	2012	50			5			123.6	1.85
	4	2012	50			5			123.6	2.2
	5	2012	50			5			123.6	2.7
	6	2012	50			4			123.6	3

# SPA V-Pulley (Taperlock)



"Australia's Only Genuine Wholesaler"

Pulley (dw)	Grooves	Bush	d2 Max	Type	L	b	d3	d1	d	App. Kg
125	1	1610	42			20			130.6	1.35
	2	1610	42			35			130.6	1.85
	3	2012	50			50			130.6	2.25
	4	2012	50			65			130.6	2.7
	5	2012	50			80			130.6	3.1
	6	2012	50			95			130.6	3.5
132	1	1610	42			20			137.6	1.6
	2	2012	50			35			137.6	2.1
	3	2012	50			50			137.6	2.55
	4	2517	65			65			137.6	2.8
	5	2517	65			80			137.6	3.3
	6	2517	65			95			137.6	3.8
140	1	1610	42			20			145.6	1.8
	2	2012	50			35			145.6	2.5
	3	2517	65			50			145.6	2.8
	4	2517	65			65			145.6	3.8
	5	2517	65			80			145.6	4
	6	2517	65			95			145.6	4.65
150	1	1610	42			20			155.6	2.2
	2	2012	50			35			155.6	3
	3	2517	65			50			155.6	3.55
	4	2517	65			65			155.6	4.1
	5	2517	65			80			155.6	4.9
	6	2517	65			95			155.6	5.2
160	1	1610	42			20			165.6	1.85
	2	2012	50			35			165.6	3.5
	3	2517	65			50			165.6	4.4
	4	2517	65			65			165.6	5.1
	5	2517	65			80			165.6	5.5
	6	2517	65			95			165.6	6.2
170	1	1610	42			20			175.6	2
	2	2012	50			35			175.6	3.3
	3	2517	65			50			175.6	4.5
	4	2517	65			65			175.6	5.9
	5	2517	65			80			175.6	6.6
180	1	1610	42			20			185.6	2
	2	2012	50			35			185.6	3.8
	3	2517	65			50			185.6	6
	4	2517	65			65			185.6	6.65
	5	3020	75			80			185.6	6.8
	6	3020	75			95			185.6	9.3
190	1	1610	42			20			195.6	2.7
	2	2012	50			35			195.6	4.4
	3	2517	65			50			195.6	5.5

"Why compete against your supplier when you can be our partner"

Pulley (dw)	Grooves	Bush	d2 Max	Type	L	b	d3	d1	d	App. Kg
200	1	2012	50			20			205.6	3
	2	2517	65			35			205.6	4.4
	3	2517	65			50			205.6	5.2
	4	3020	75			65			205.6	8.3
	5	3020	75			80			205.6	8.9
	6	3020	75			95			205.6	9.8
212	1	2012	50			20			217.6	2.9
	2	2517	65			35			217.6	4.7
	3	2517	65			50			217.6	6
	4	3020	75			65			217.6	8
224	1	2012	50			20			229.6	3.25
	2	2517	65			35			229.6	5.25
	3	2517	65			50			229.6	6.2
	4	3020	75			65			229.6	11.2
	5	3020	75			80			229.6	12.1
	6	3020	75			95			229.6	13.4
236	1	2012	50			20			241.6	3.2
	2	2517	65			35			241.6	5.4
	3	2517	65			50			241.6	6.6
	4	3020	75			65			241.6	9.8
	5	3020	75			80			241.6	12.2
250	1	2012	50			20			255.6	3.8
	2	2517	65			35			255.6	5.8
	3	2517	65			50			255.6	6.55
	4	3020	75			65			255.6	9.7
	5	3020	75			80			255.6	10.5
	6	3020	75			95			255.6	11.7
280	1	2012	50			20			285.6	4.7
	2	2517	65			35			285.6	6.4
	3	2517	65			50			285.6	8.9
	4	3020	75			65			285.6	10.40
	5	3535	90			80			285.6	15.1
	6	3535	90			95			285.6	16.7
300	1	2012	50			20			305.6	
	2	2517	65			35			305.6	4.3
	3	3020	75			50			305.6	6.2
315	1	2012	50			20			320.6	4.9
	2	2517	65			35			320.6	7.5
	3	3020	75			50			320.6	11.8
	4	3020	75			65			320.6	15.5
	5	3535	90			80			320.6	17.3
	6	3535	90			95			320.6	18.9
335	4	3020	75			65			340.6	12.8
355	1	2012	50			20			360.6	5.5
	2	2517	65			35			360.6	8.8
	3	3020	75			50			360.6	12.2
	4	3020	75			65			360.6	13.5
	5	3535	90			80			360.6	20.2
	6	3535	90			95			360.6	21

# SPA V-Pulley (Taperlock)



"Australia's Only Genuine Wholesaler"

Pulley (dw)	Grooves	Bush	d2 Max	Type	L	b	d3	d1	d	App. Kg
400	1	2012	50			20			405.6	5.91
	2	2517	65			35			405.6	9.35
	3	3020	75			50			405.6	13.32
	4	3020	75			65			405.6	15.45
	5	3535	90			80			405.6	22.09
	6	3535	90			95			405.6	24.25
450	1	2012/2517	50/65			20			455.6	6.77
	2	2517	65			35			455.6	10.62
	3	3020	75			50			455.6	15.11
	4	3020	75			65			455.6	17.94
	5	3535	90			80			455.6	24.65
	6	3535	90			95			455.6	27.31
500	1	2517	65			20			505.6	6.5
	2	2517	65			35			505.6	12.11
	3	3020	75			50			505.6	17.09
	4	3020	75			65			505.6	20.07
	5	3535	90			80			505.6	27.33
	6	3535	90			95			505.6	30.55
630	1	2517	65			20			635.6	16.00
	2	3020	75			35			635.6	17.8
	3	3020	75			50			635.6	22.68
	4	3535	90			65			635.6	31.17
	5	3535	90			80			635.6	35.31
	6	4040	100			95			635.6	47.72
800	3	3535	90			50			805.6	34.76
	4	3535	90			65			805.6	41.11
	5	4040	100			80			805.6	54.54
	6	4040	100			95			805.6	59.75
1000	3	3535	90			50			1005.6	45.99
	4	4040	100			65			1005.6	63.94
	5	4545	110			80			1005.6	76.41
	6	4545	110			95			1005.6	85.40



## V-Belt Pulley

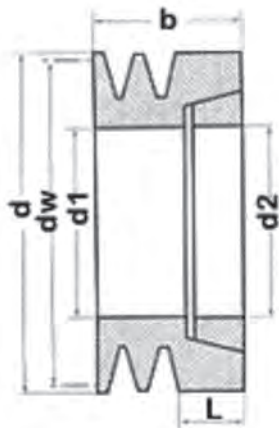

Type 1

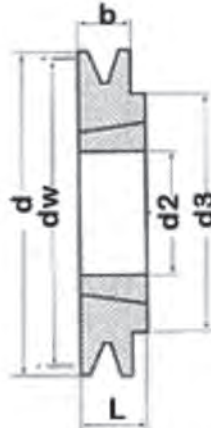

Type 2

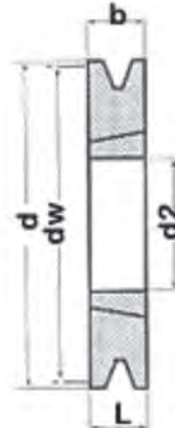

Type 3

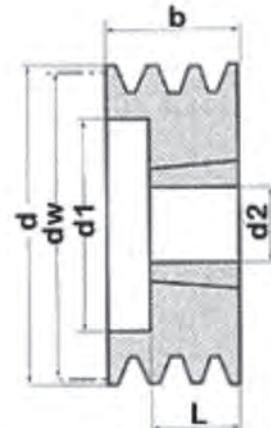

Type 4

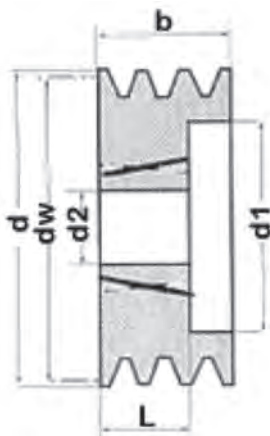

Type 5

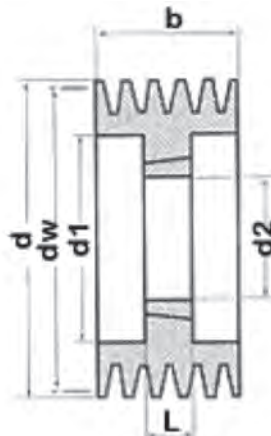

Type 6

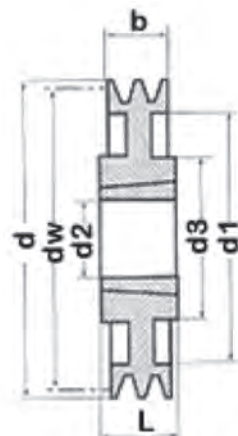

Type 7

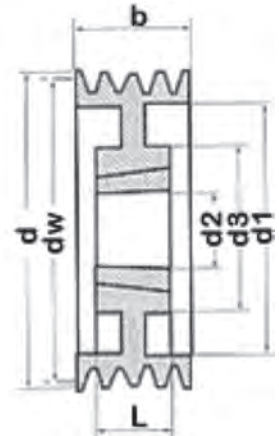

Type 8

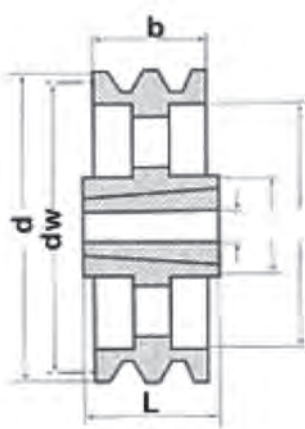

Type 9

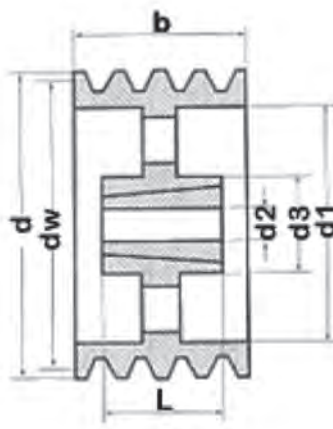

Type 10

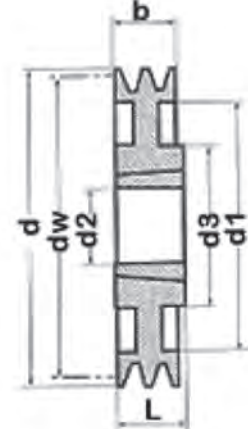

Type 11