

"Why compete against your supplier when you can be our partner"

Pulley (dw)	Grooves	Bush	d2 Max	Type	L	b	d3	d1	d	App. Kg
150	1	2012/2517	50/65			50			159.6	6
200	1	2517	65			50			209.6	8
	3	2517	60			85			209.6	10.41
	4	3020	75			110.5			209.6	11.57
	5	3020/3535	75/90			136			209.6	14.38
	6	3535	90			161.5			209.6	16.13
	8	3535	90			212.5			209.6	16.93
212	3	2517/3020	65/75			85			221.6	11.35
	4	3020	75			110.5			221.6	13.22
	5	3535	90			136			221.6	16.98
	6	3535	90			161.5			221.6	18.85
	8	3535	90			212.5			221.6	22.59
224	1	2517	65			50			233.6	10.00
	2	3020	75			59.5			233.6	10.97
	3	3020	75			85			233.6	12.97
	4	3535	90			110.5			233.6	17.72
	5	3535	90			136			233.6	19.71
	6	3535	90			161.5			233.6	21.71
	8	3535	90			212.5			233.6	25.69
236	3	3020	75			85			245.6	14.67
	4	3535	90			110.5			245.6	20.49
	5	3535	90			136			245.6	22.6
	6	3535	90			161.5			245.6	24.72
	8	3535	90			212.5			245.6	28.94
250	2	3020	75			50			259.6	14.00
	3	3020	75			85			259.6	16.76
	4	3535	90			110.5			259.6	23.91
	5	3535	90			136			259.6	26.16
	6	3535	90			161.5			259.6	28.42
	8	3535	90			212.5			259.6	32.93
265	3	3535	90			85			274.6	25.04
	4	3535	90			110.5			274.6	21.11
	5	3535	90			136			274.6	23.52
	6	3535	90			161.5			274.6	26.01
	8	3535	90			212.5			274.6	30.91
280	3	3535	90			85			289.6	19.55
	4	3535	90			110.5			289.6	22.23
	5	3535	90			136			289.6	24.91
	6	3535	90			161.5			289.6	27.6
	8	3535	90			212.5			289.6	32.84
300	3	3535	90			85			309.6	21.01
	4	3535	90			110.5			309.6	23.95
	5	3535	90			136			309.6	26.89
	6	3535	90			161.5			309.6	29.83
	8	4040	100			212.5			309.6	49.93
	10	4545	110			263.5			309.6	54

SPC V-Pulley (taperlock)



"Australia's Only Genuine Wholesaler"

Pulley (dw)	Grooves	Bush	d2 Max	Type	L	b	d3	d1	d	App. Kg
315	3	3535	90			85			324.6	22.04
	4	3535	90			110.5			324.6	25.18
	5	3535	90			136			324.6	28.32
	6	3535	90			161.5			324.6	31.45
	8	4040	100			212.5			324.6	44.28
	10	4545	110			263.5			324.6	60
335	3	3535	90			85			344.6	22.60
	4	3535	90			110.5			344.6	27.60
	5	3535	90			136			344.6	31.11
	6	3535	90			161.5			344.6	34.62
	8	4040	100			212.5			344.6	47.97
	10	4545	110			263.5			344.6	81
	12	5050	125			314.5			344.6	124
355	3	3535	90			85			364.6	26.01
	4	3535	90			110.5			364.6	29.44
	5	3535	90			136			364.6	33.23
	6	3535	90			161.5			364.6	37.02
	8	4040	100			212.5			364.6	51.05
	10	4545	110			263.5			364.6	85
	12	5050	125			314.5			364.6	124
375	3	3535	90			85			384.6	25.1
	4	3535	90			110.5			384.6	30.72
	5	3535	90			136			384.6	35.84
	6	4040	100			161.5			384.6	46.39
	8	4545	110			212.5			384.6	59.70
	10	4545	110			263.5			384.6	92
	12	5050	125			314.5			384.6	138
400	3	3535	90			85			409.6	28.14
	4	3535	90			110.5			409.6	33.24
	5	3535	90			136			409.6	38.32
	6	4040	100			161.5			409.6	50.20
	8	4545	110			212.5			409.6	63.87
	10	4545	125			263.5			409.6	73
	12	5050	125			314.5			409.6	156
425	3	3535	90			85			434.6	28.75
	4	3535	90			110.5			434.6	33.76
	5	3535	90			136			434.6	45.51
	6	4040/4545	100/110			161.5			434.6	56.22
	8	4545/5050	110/125			212.5			434.6	64.97
	10	5050	125			263.5			434.6	105
	12	5050	125			314.5			434.6	130
450	3	3535	90			85			459.6	30.39
	4	3535	90			110.5			459.6	35.9
	5	4040	100			136			459.6	47.85
	6	4545	110			161.5			459.6	58.92
	8	5050	125			212.5			459.6	73.99
	10	5050	125			263.5			459.6	94
	12	5050	125			314.5			459.6	133

"Why compete against your supplier when you can be our partner"

Pulley (dw)	Grooves	Bush	d2 Max	Type	L	b	d3	d1	d	App. Kg
475	3	3535	90			85			484.6	32.46
	4	3535	90			110.5			484.6	38.41
	5	4040	100			136			484.6	50.60
	6	4545	110			161.5			484.6	61.46
	8	5050	125			212.5			484.6	77.64
	10	5050	125			263.5			484.6	125
	12	5050	125			314.5			484.6	142
500	3	3535	90			85			509.6	34.52
	4	3535	90			110.5			509.6	41.06
	5	4040	100			136			509.6	53.49
	6	4545	110			161.5			509.6	64.69
	8	5050	125			212.5			509.6	81.31
	10	5050	125			263.5			509.6	111
	12	5050	125			314.5			509.6	148
530	3	3535	90			85			539.6	36.82
	4	3535/4040	90/100			110.5			539.6	50.27
	5	4040/4545	100/4545			136			539.6	62.18
	6	4545	110			161.5			539.6	73.77
	8	5050	125			212.5			539.6	85.60
	10	5050	125			263.5			539.6	145
	12	5050	125			314.5			539.6	155
560	3	3535	90			85			569.6	39.41
	4	4040	100			110.5			569.6	53.43
	5	4545	110			136			569.6	65.72
	6	5050	125			161.5			569.6	77.67
	8	5050	125			212.5			569.6	90.9
	10	5050	125			263.5			569.6	121
	12	5050	125			314.5			569.6	164
630	3	4040	100			85			639.6	52.10
	4	4545	110			110.5			639.6	66.03
	5	5050	125			136			639.6	79.3
	6	5050	125			161.5			639.6	87.39
	8	5050	125			212.5			639.6	102.88
	10	5050	125			263.5			639.6	130
	12	5050	125			314.5			639.6	185
800	3	4545	110			85			809.6	72
	4	5050	125			110.5			809.6	90.77
	5	5050	125			136			809.6	102.46
	6	5050	125			161.5			809.6	113.65
	8	5050	125			212.5			809.6	136.55
	10	5050	125			263.5			809.6	170
	12	6050	150			314.5			809.6	277
1000	4	5050	125			110.5			1009.6	117.11
	5	5050	125			136			1009.6	133.59
	6	5050	125			161.5			1009.6	149.8
	8	5050	125			212.5			1009.6	181.35
	10	5050	125			263.5			1009.6	230
	12	6050	150			314.5			1009.6	346
1250	5	5050	125			136			1259.6	187
	6	5050	125			161.5			1259.6	200
	8	5050	125			212.5			1259.6	252

V-Belt Pulley

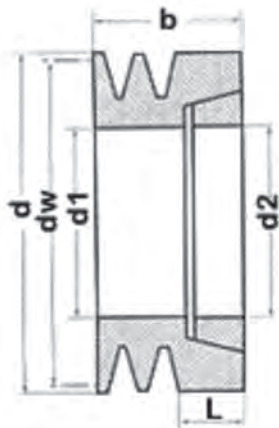

Type 1

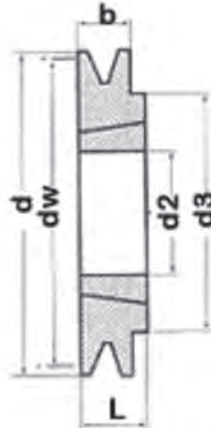

Type 2

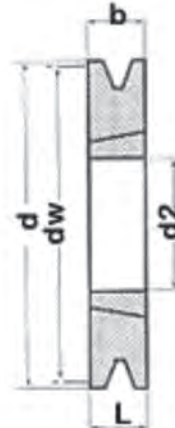

Type 3

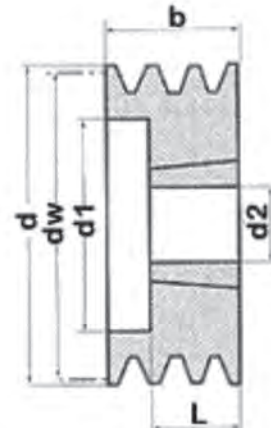

Type 4

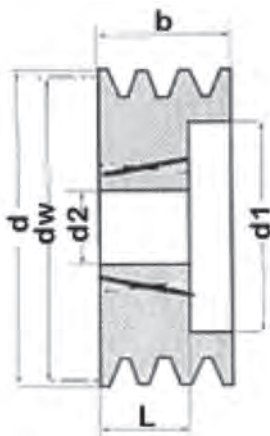

Type 5

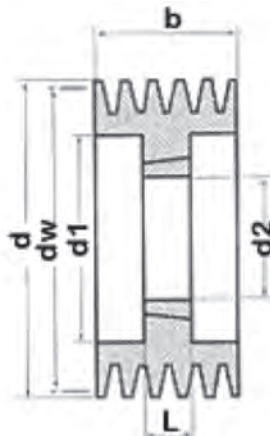

Type 6

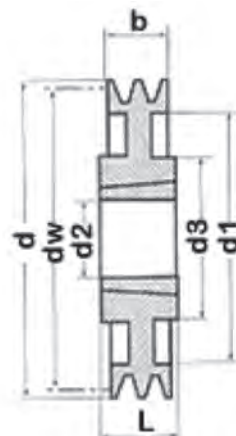

Type 7

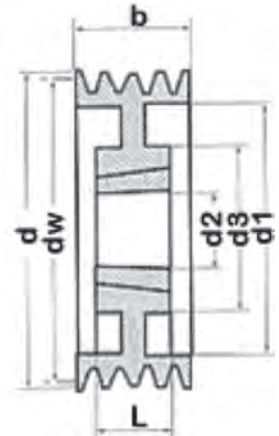

Type 8

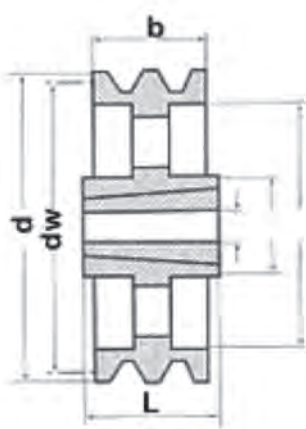

Type 9

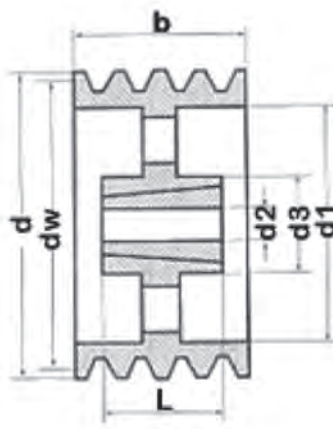

Type 10

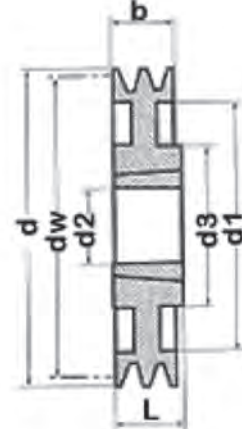

Type 11